

RÂTELIER À VERRES 5 RANGÉES

MB2

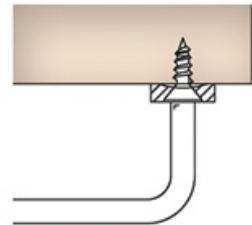

<https://www.qama.fr/ratelier-a-verres-5-rangees-p64274>

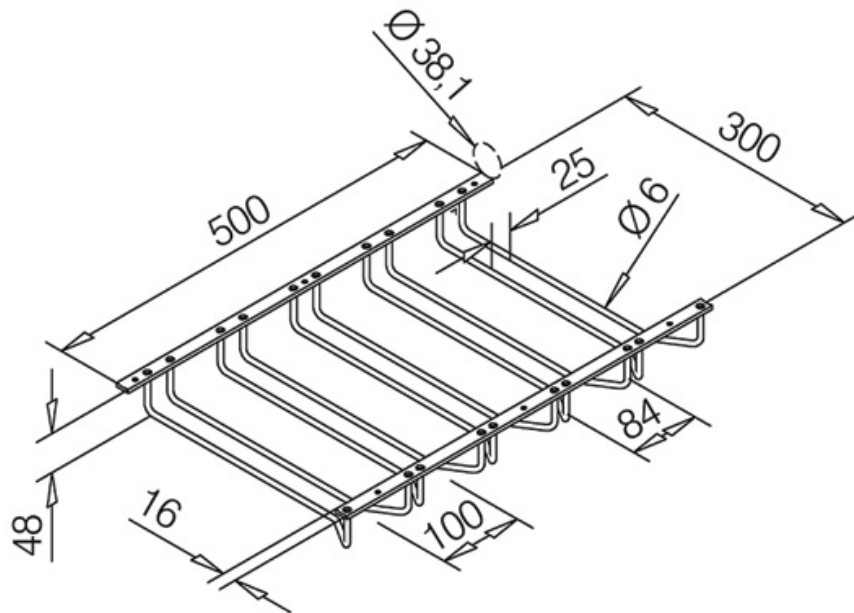

Tel : 02 43 13 49 49

Fax : 02 43 30 26 16

www.qama.fr