

KIT ARCITECH 94 AVEC BANDEAUX HAUTEUR 218

HETTICH

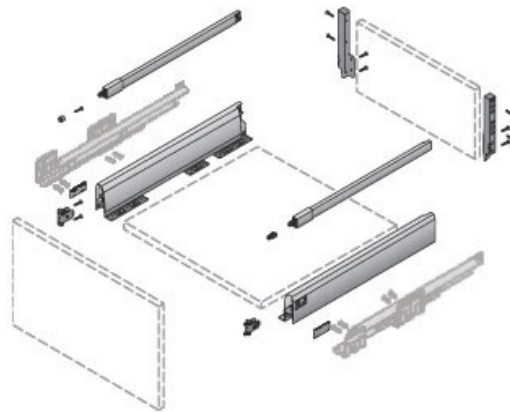

<https://www.qama.fr/kit-arcitech-94-avec-bandeaux-hauteur-218-p31237>



Tel : 02 43 13 49 49

Fax : 02 43 30 26 16

www.qama.fr