

Montage porte avec serrure à rouleau profils porte ouvrante 40 - 40

- Porte battante avec Profils porte ouvrante 40 / 40
- Serrure à rouleau seule ou serrure à rouleau avec pêne dormant
 - Demi-cylindre 10x35 (ovale) avec 3 clés
 - Poignée de tirage

Fermeture à clé SEULEMENT côté charnière avec le pêne demi-cylindre



Montage porte avec béquille profils porte ouvrante 40 - 66

- Porte battante avec Profils porte ouvrante 40 / 66
- Serrure pêne 1/2 tour et pêne dormant
 - Cylindre entier 35x35 (européen) avec 3 clés
 - Béquilles + rosaces ovales



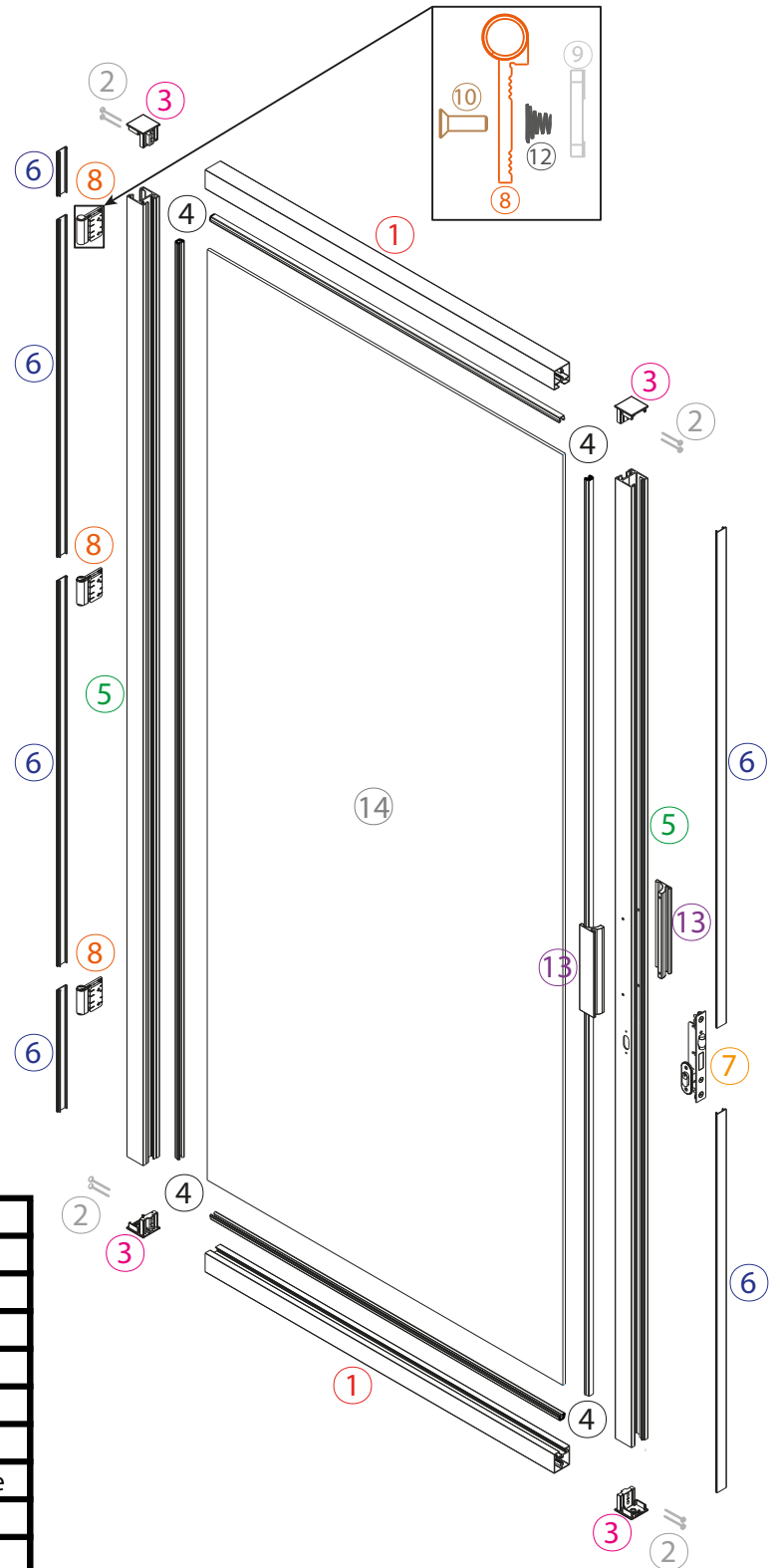
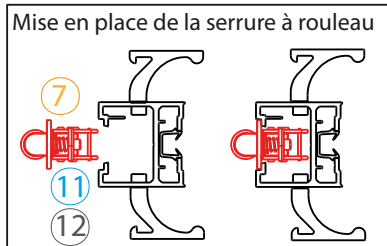
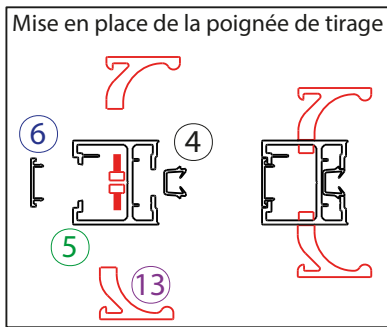
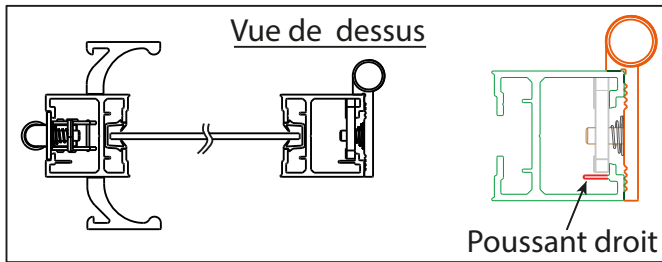
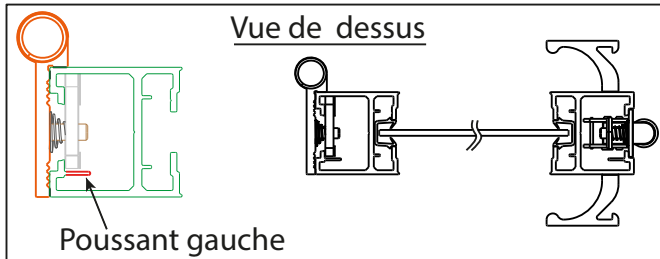

N°	Qté	Désignation
1	2	Profil traverse haute et basse 40
2	8	Vis 4,8x50 auto foreuse
3	4	Capot d'assemblage porte ouvrante 40
4	4	Profil de vitrage 6/8
5	2	Profil porte ouvrante 40
6	6	Profil plat de finition 23
7	1	Serrure à rouleau avec pêne + demi-cylindre
8	3	Paumelle supérieur
9	3	Insert de fixation double
10	8	Vis de fixation M5x16
11	2	Insert de fixation simple
12	8	Ressort de fixation
13	2	Poignée de tirage + vis
14	1	Remplissage 6/8

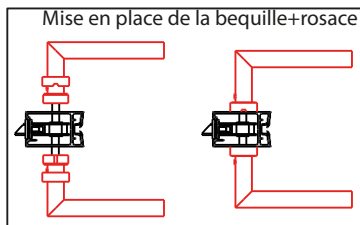
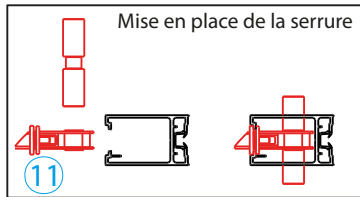
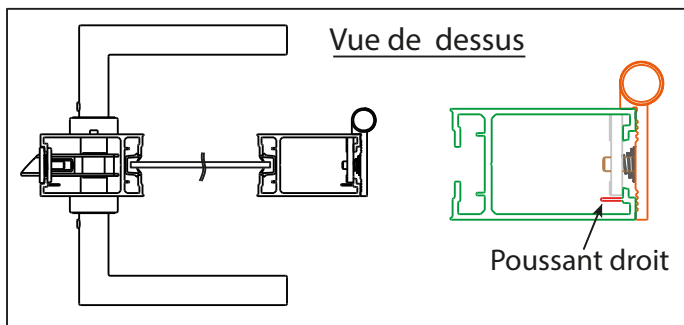
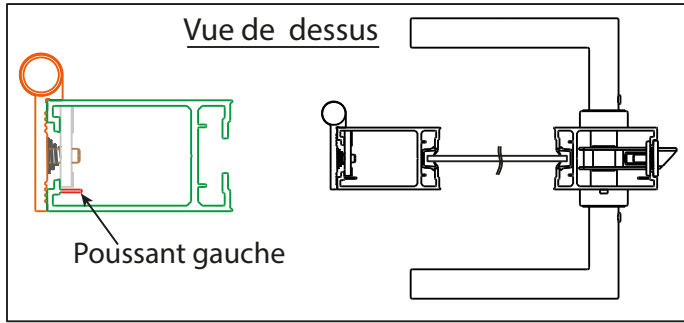



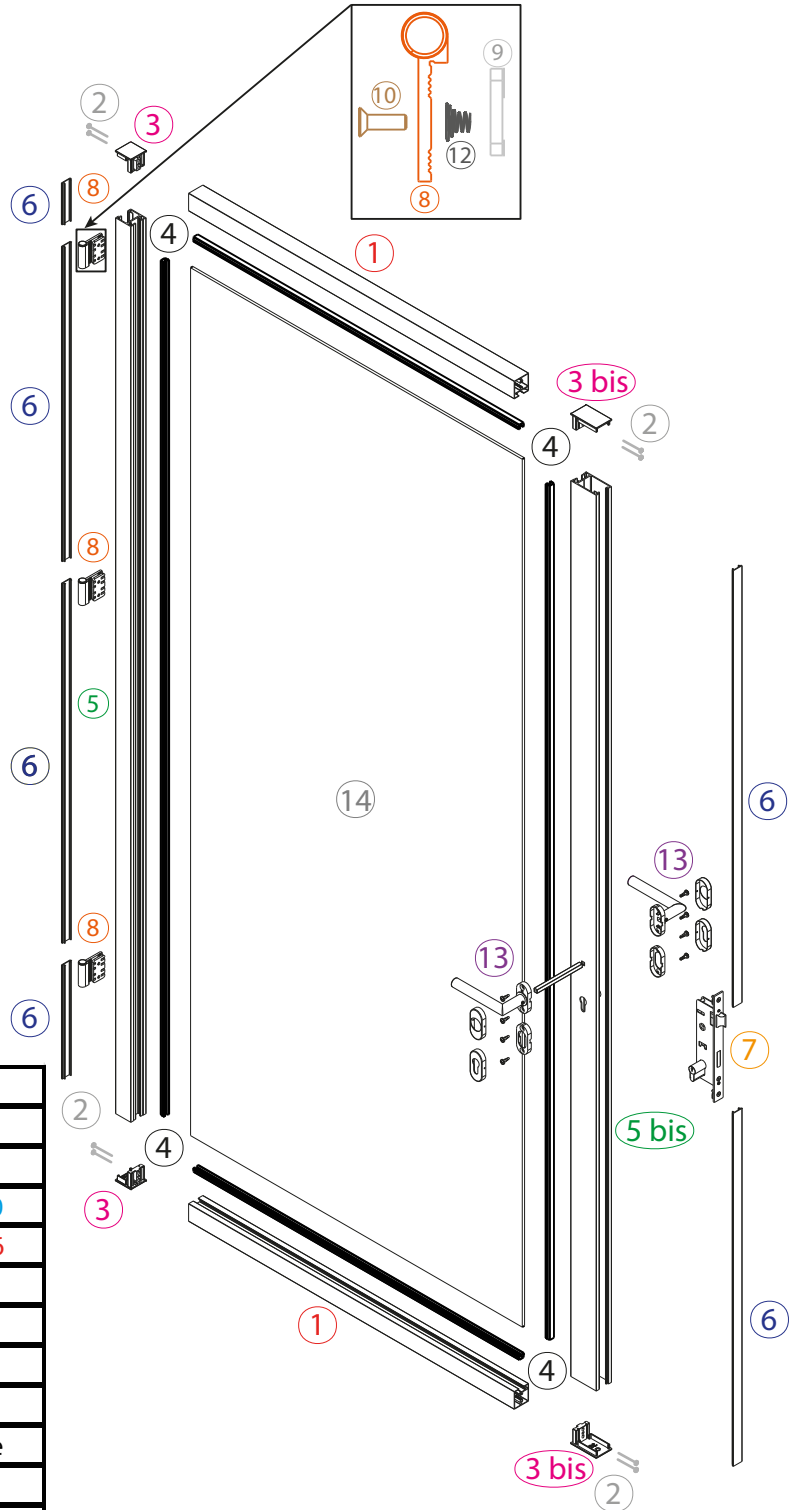

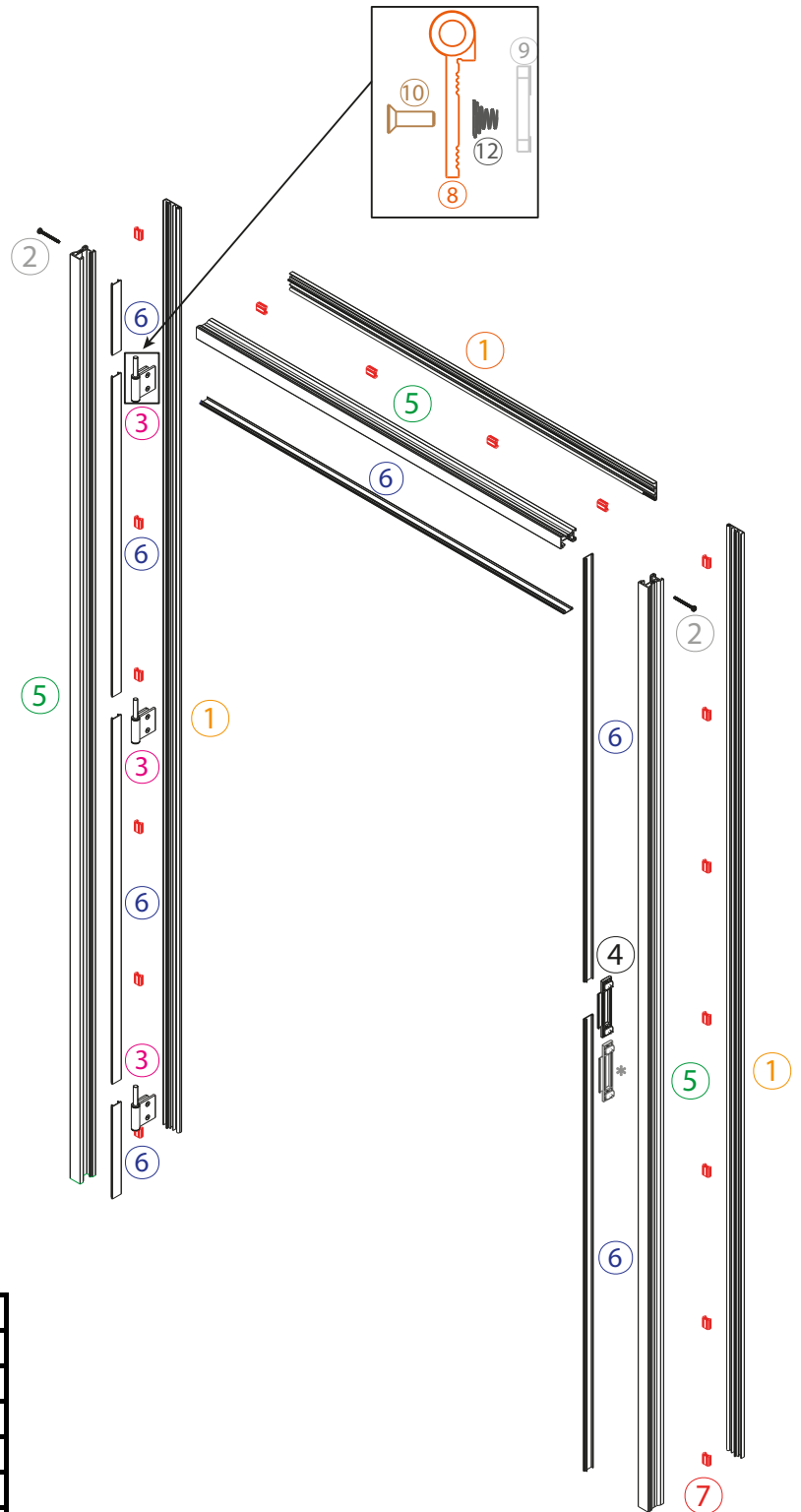
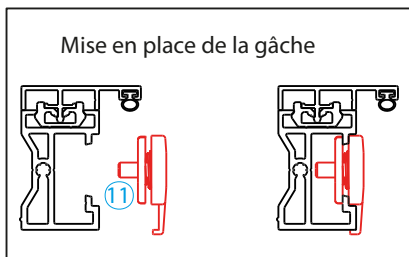
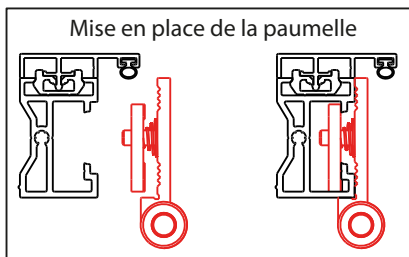
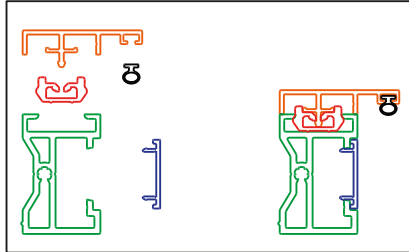





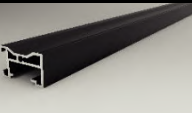
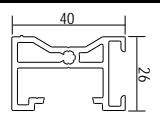

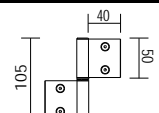
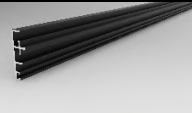
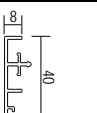

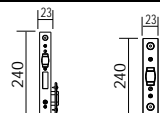

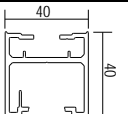

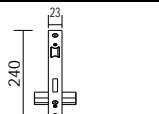

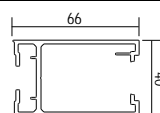

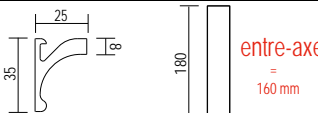
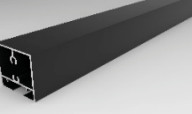
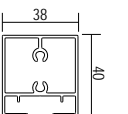

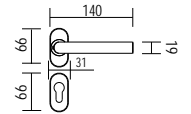
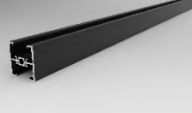
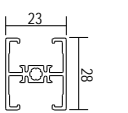

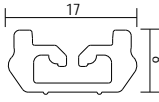
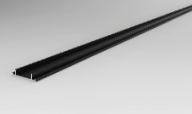
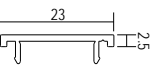

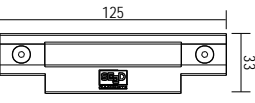

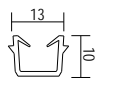

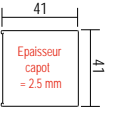
N°	Qté	Désignation
1	2	Profil traverse haute et basse 40
2	8	Vis 4,8x50 auto foreuse
3	2	Capot d'assemblage porte ouvrante 40
3 bis	2	Capot d'assemblage porte ouvrante 66
4	4	Profil de vitrage 6/8
5	1	Profil porte ouvrante 40
5 bis	1	Profil porte ouvrante 66
6	6	Profil plat de finition 23
7	1	Serrure pêne demi-tour + cylindre
8	3	Paumelle supérieur
9	3	Insert de fixation double
10	8	Vis de fixation M5x16
11	2	Insert de fixation simple
12	8	Ressort de fixation
13	2	Béquille + Rosace ovale
14	1	Remplissage 6/8

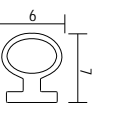

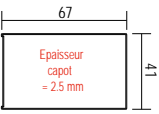

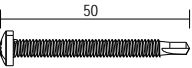
N°	Qté	Désignation
1	3	Profil parclose dormant 26
2	2	Vis 4,8x50 auto foreuse
3	3	Paumelle inférieur
4	1*	Gâche de fermeture
5	3	Profil dormant 26
6	7	Profil plat de finition 23
7	18	Clips
8	3	Ailette paumelle inférieur
9	3	Insert de fixation double
10	8	Vis de fixation M5x16
11	2	Insert de fixation simple
12	8	Ressort de fixation

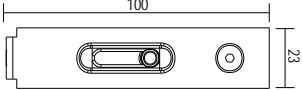
* 2 gâches si serrure avec pêne demi-tour et dormant (béquille)

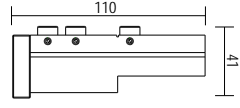
PROFIL DORMANT 26		PAUMELLE COMPLETE	
			
PROFIL PARCLOSE DORMANT 26		SERRURE A ROULEAU SEUL OU + PENE + 1/2 CYLINDRE	
			
PROFIL PORTE OUVRANTE 40		SERRURE AVEC PENE + CYLINDRE	
			
PROFIL PORTE OUVRANTE 66		POIGNEE DE TIRAGE - 180MM	
			
PROFIL TRAVERSE HAUTE ET BASSE 40		BEQUILLES + ROSACES	
			
PROFIL TRAVERSE INTERMEDIAIRE 28		CLIPS	
			
PROFIL PLAT DE FINITION 23		GACHE DE FERMETURE	
			
PROFIL DE VITRAGE 6/8		CAPOT D'ASSEMBLAGE PORTE OUVRANTE 40	
			
JOINT BULLE		CAPOT D'ASSEMBLAGE PORTE OUVRANTE 66	
			
VIS 4,8X50 AUTO-FOREUSE (Embout PH2)		VERROU A ONGLET	
			
GABARIT DE PERCAGE			
			

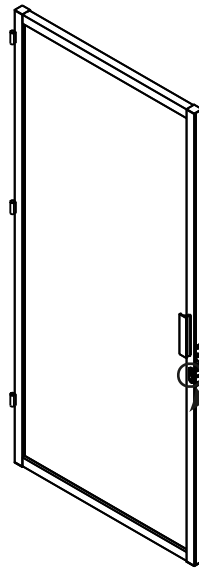
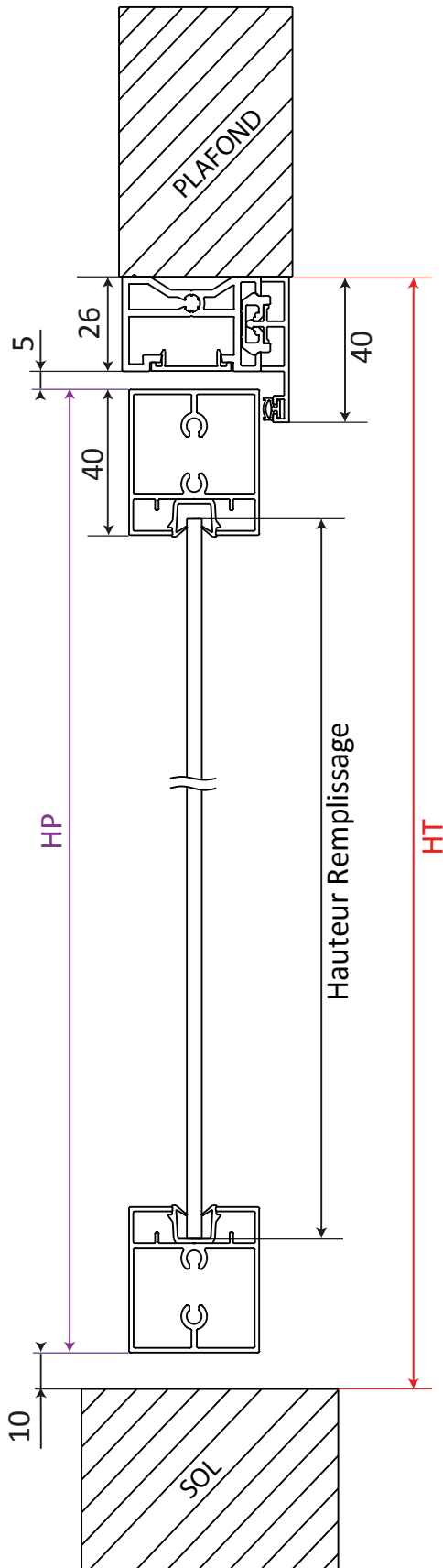

Montage porte avec serrure à rouleau Profils 40-40

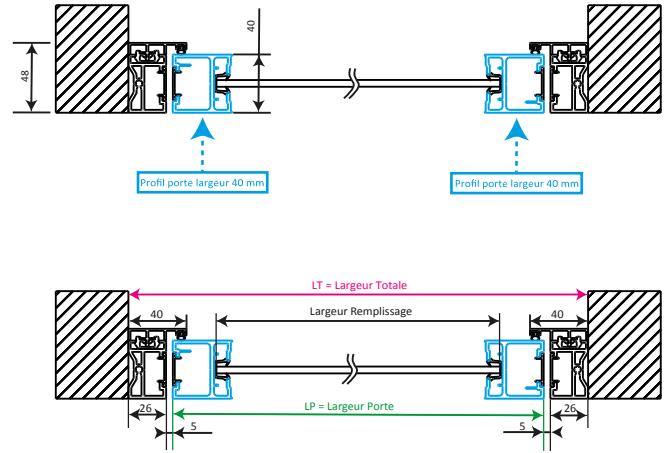

- Porte battante avec profils porte 40 / 40
- Serrure à rouleau ou
 - Serrure à rouleau + pêne demi-cylindre (fermeture à clé côté charnière)
 - poignée de tirage

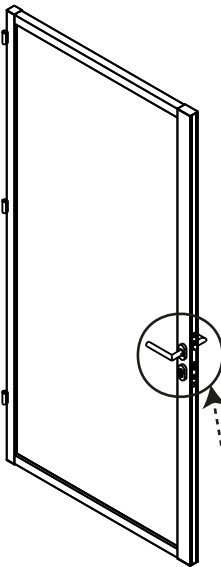

Montage porte avec béquille Profils 40-66

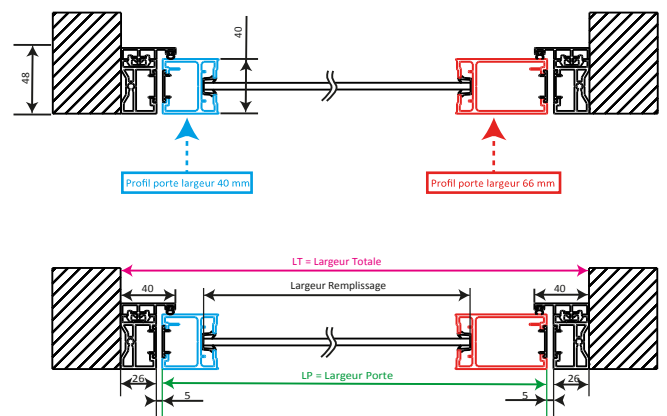

- Porte battante avec profils porte 40 / 66
- Serrure pêne 1/2 tour et pêne dormant
 - cylindre entier 35x35 avec 3 clés
 - béquilles + rosaces ovales